

art.531/A

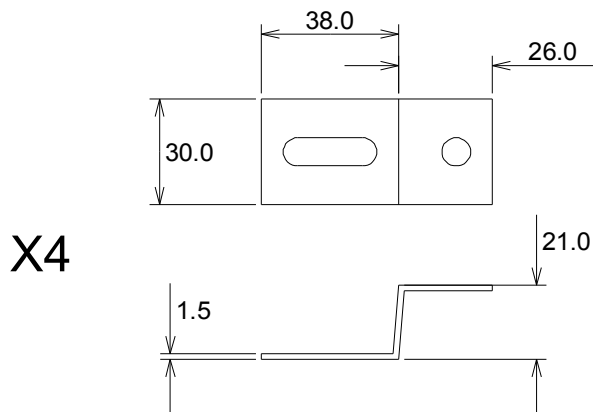

X4

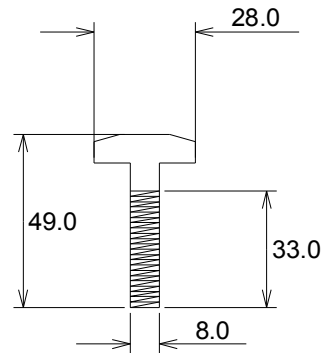

X4

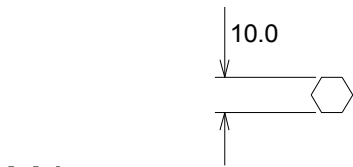

X4

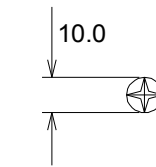

X4

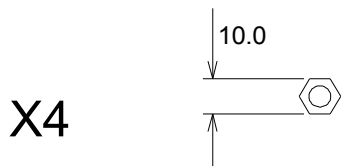
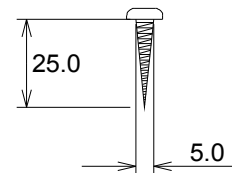
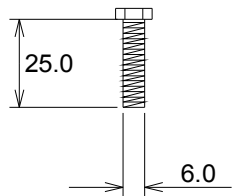

X4



X4

