

art.527

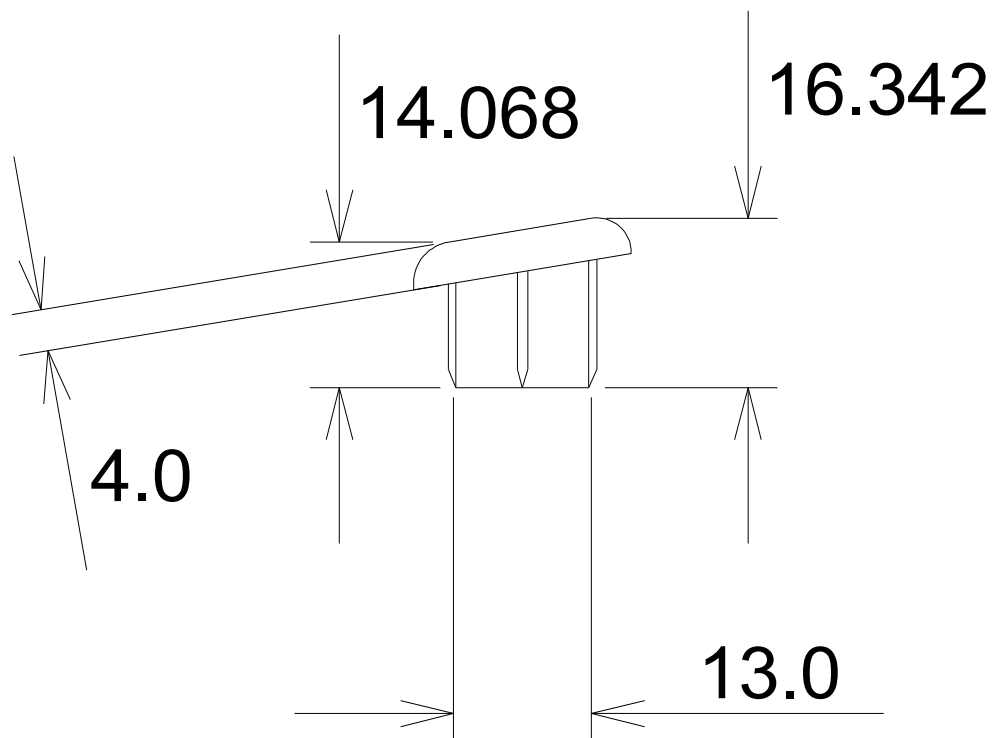
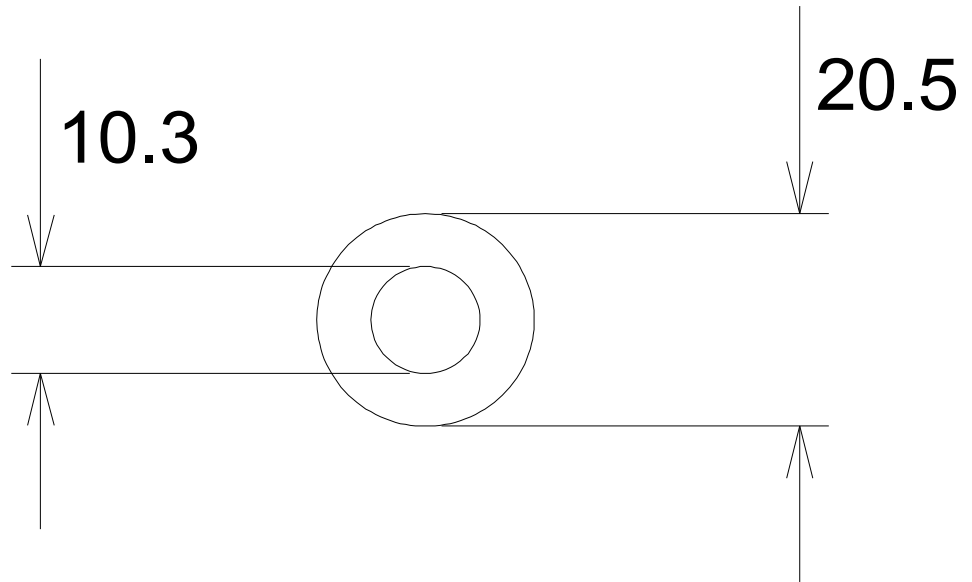

Perini srl s.p. 150 km 3.400 Gallese (VITERBO)