

art. 1018

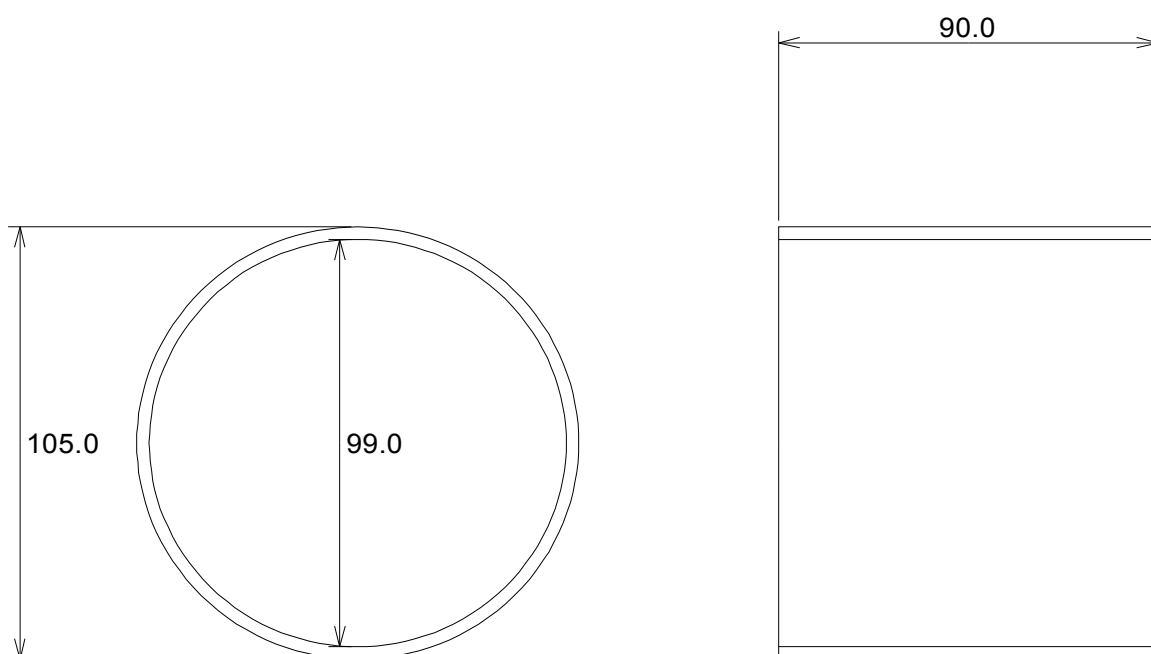

Perini srl s.p. 150 km 3.400 Gallese (VITERBO)